

Ball Lock Pins with Ring Handle- single acting - according to NASM / MS 17987

4213.E19



Product Description

Quick Release Pins according to NASM (former norm: MS) are used for quick fastening, locking, adjusting, changing and securing. Quickly and easily unlockable for frequently repeated connections.

Quick Release Pins (Single Acting Ball Lock Pins / Ball Lock Pins) are produced according to Aviation Norm NASM (former norm: MS) and tested to NAS 1332.

A standard program is available from stock (refer to article table). Delivery time for customer orders and dimensions not mentioned here currently 8 weeks. Please note the minimum order quantity of 20 pieces.

Material

Pin ①

- Stainless steel, precipitation-hardened, passivated

Press bolt ②

- Stainless steel, precipitation-hardened, passivated

Spring ③

- Stainless steel, precipitation-hardened, passivated

Handle ④

- Stainless steel, passivated

Attaching ring ⑤

- Stainless steel, passivated

Ball ⑥

- Stainless steel, precipitation-hardened, passivated

Operation

The balls are unlocked by pressing the knob.

More information

Notes

Special types on request.

All further dimensions are available on request.

Further products

- Warning Streamers, according to NAS1756

Drawing

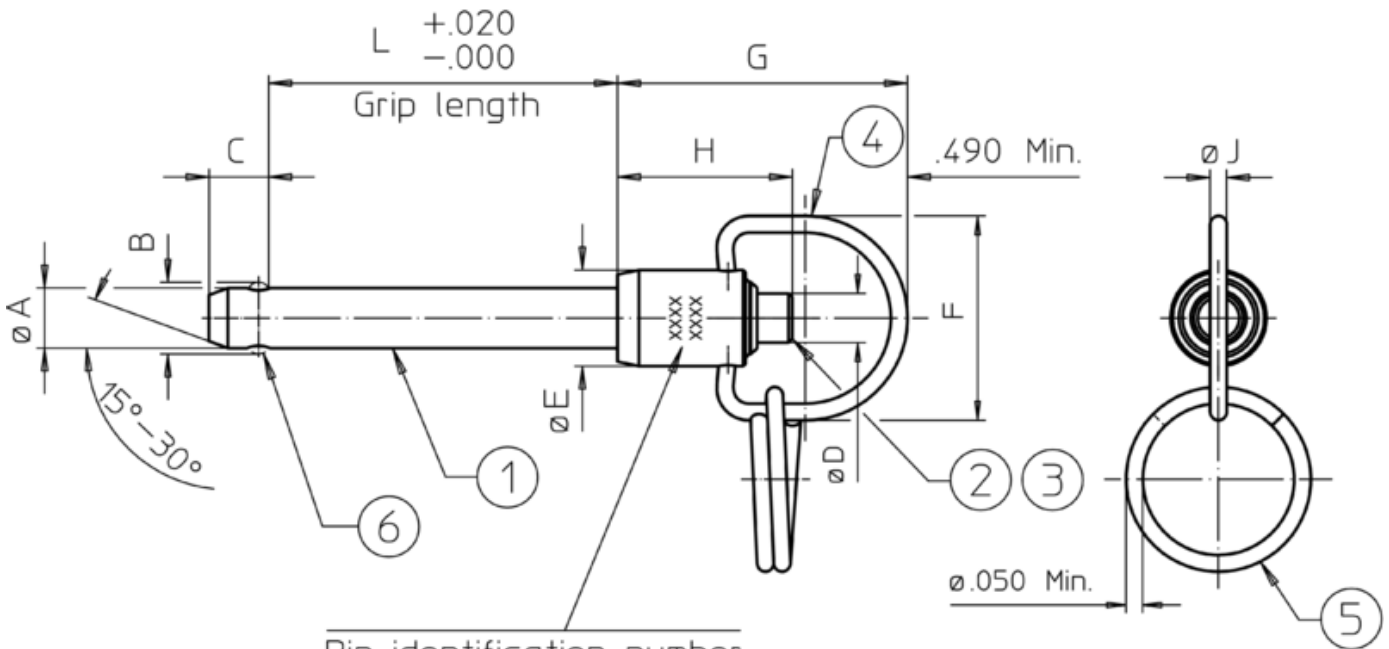

Pin identification number

Example:

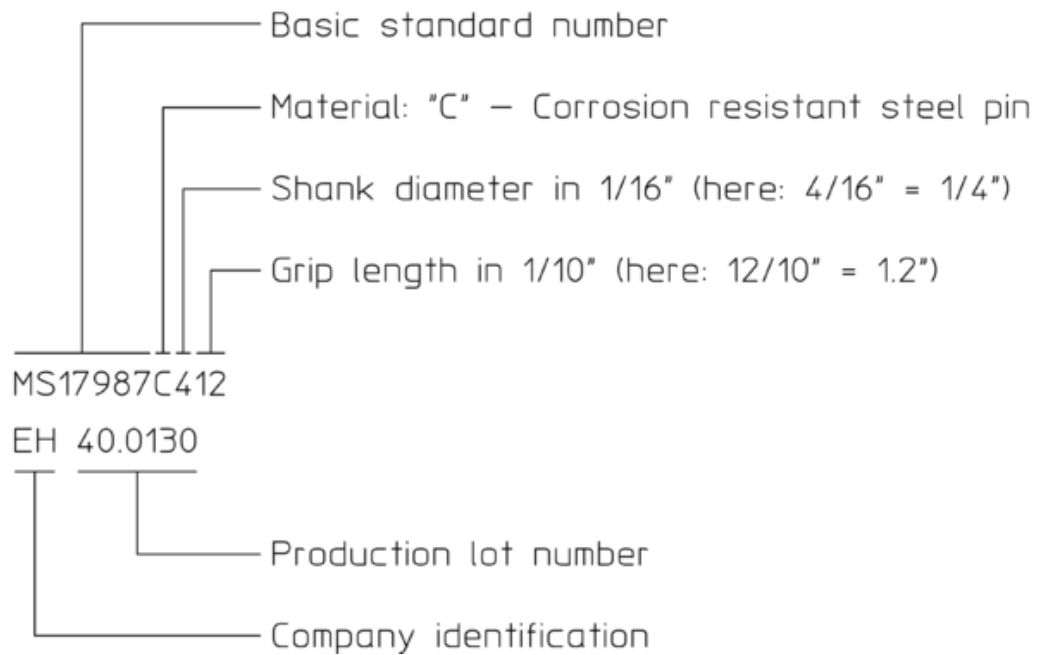

Ball positions may be different than shown in the drawing (rotation may be possible).

Order information

Nominal diameter A	Clamping Length L $+0,02$ 0	B $\pm 0,005$	Dimensions						Location hole max.	Shearing resistance, double ¹⁾ min.	Temperature		Weight [g]	Art. No.
			C 0 -0,04	D max.	E max.	G max.	H min.	J min.			min.	max.		
[inch]	[inch]		[inch]						[inch]	[lb]	[°F]			
7/16	1,9	0,509	0,38	0,39	0,71	1,85	0,98	0,08	0,4425	28,500	-22	302	77	4213.E19

¹⁾ Shearing resistance similar to DIN 50141